

Tork Signage Holder® for Soap and Sanitizer Dispenser

Elevation
Design

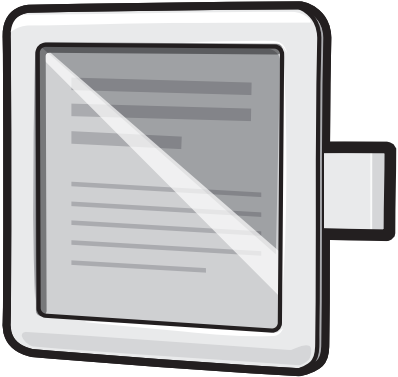

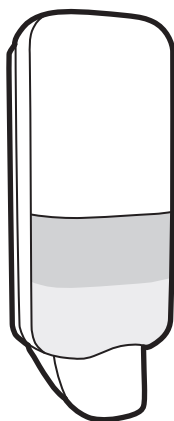
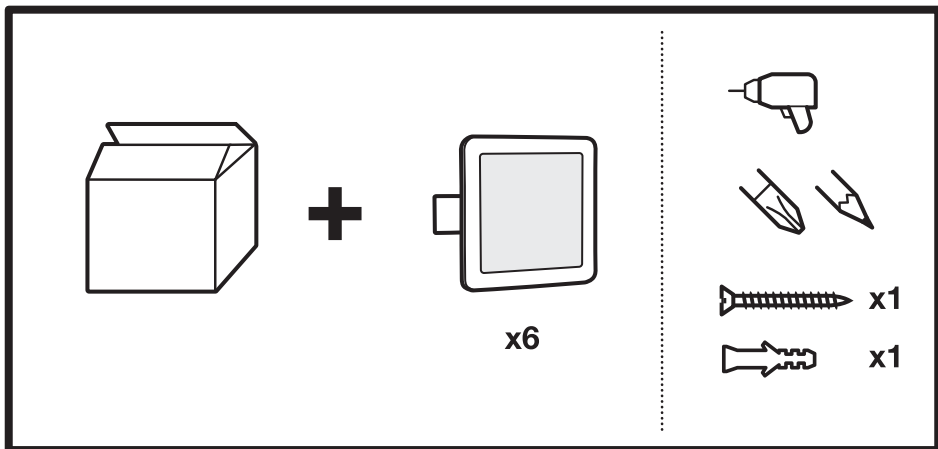

S4

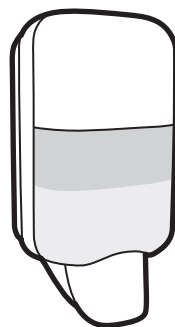
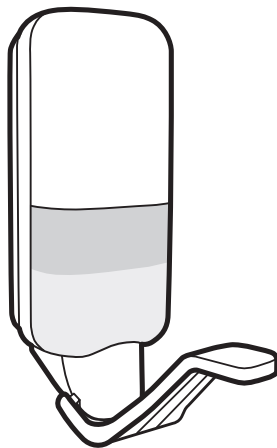

S5

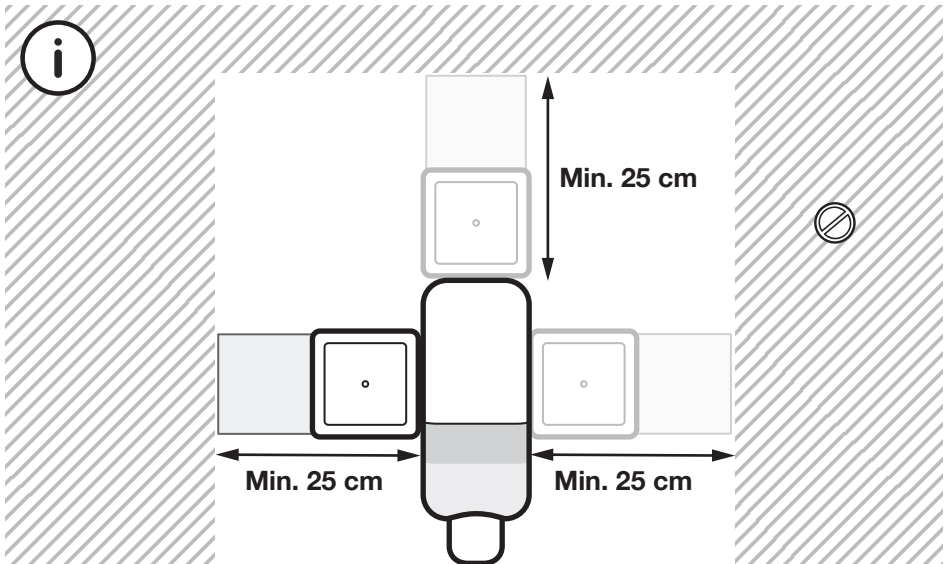
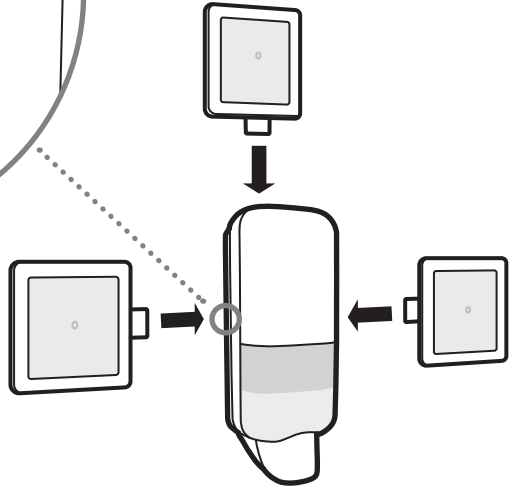
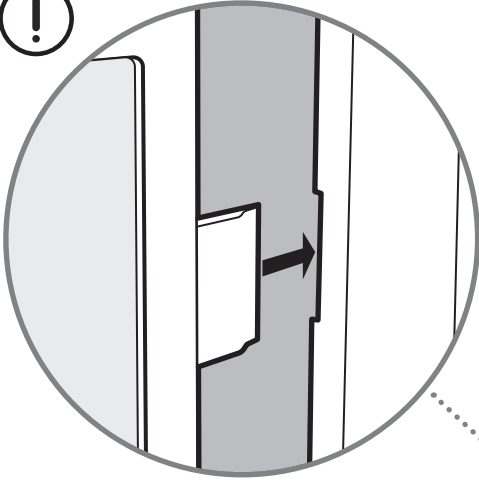

Alt 1

1

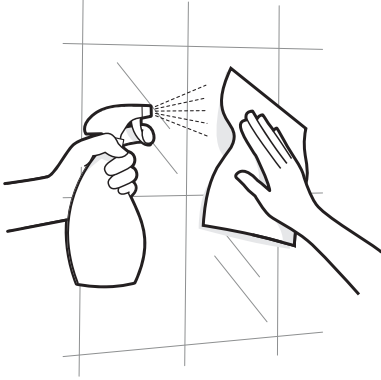

2

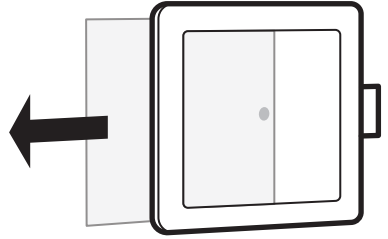

3

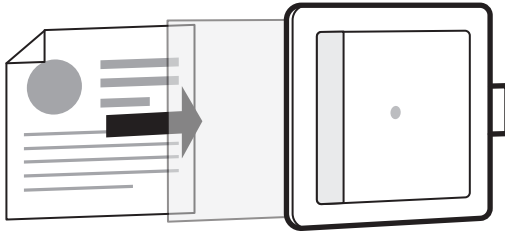

4

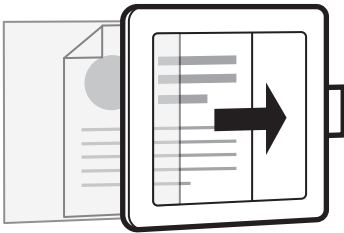

5

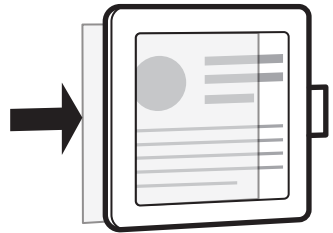

6

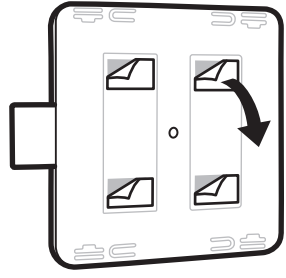

7

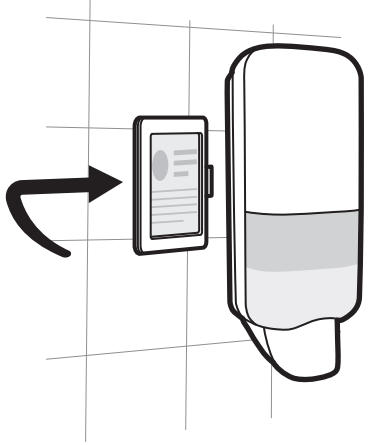

8

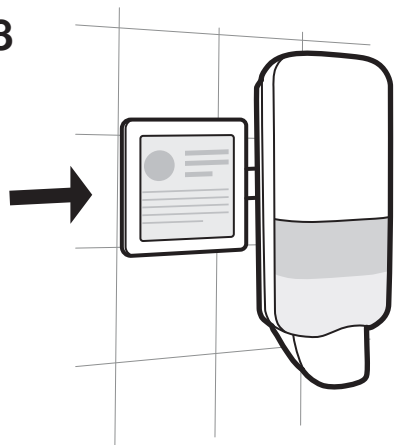

9

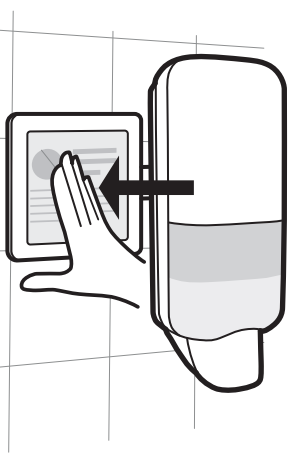

10

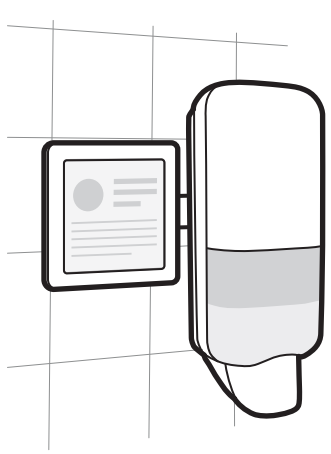

Alt 2

1

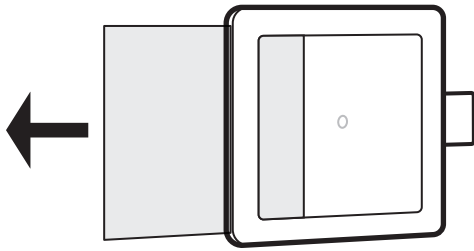

2

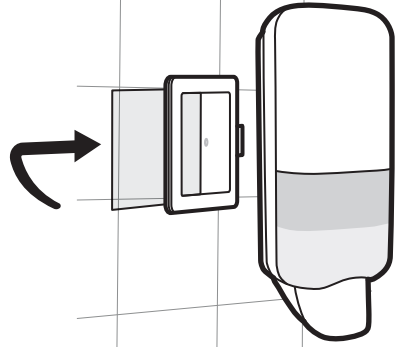

3

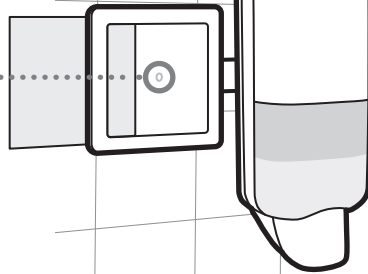
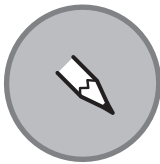

4

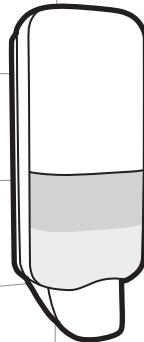
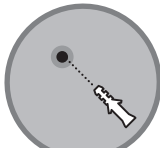

5

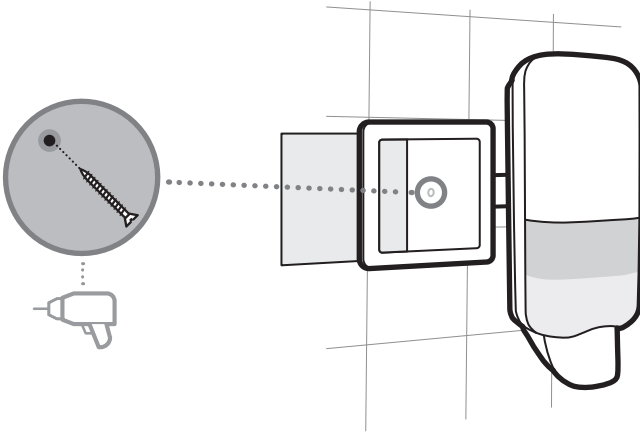

6

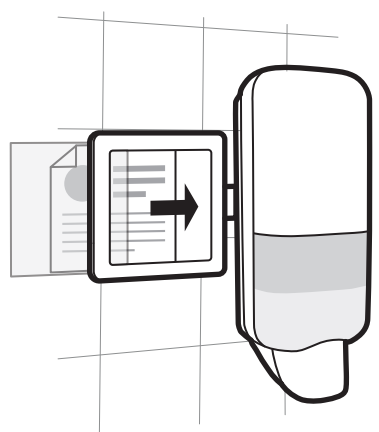
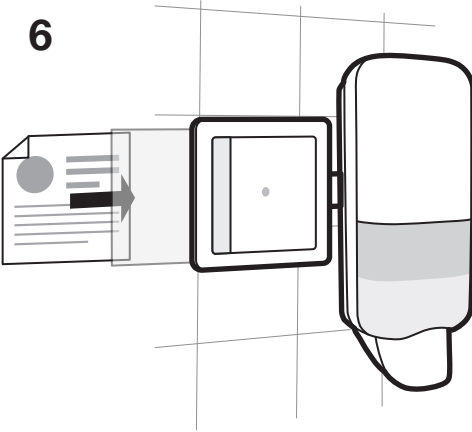

7

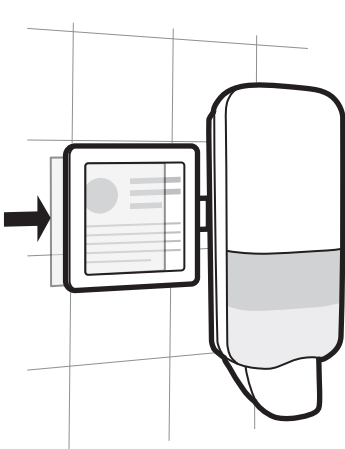

8

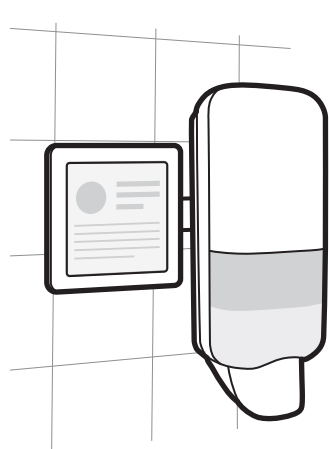

Warning

- To avoid a potential shock hazard to dispenser users, do not install dispenser directly above an electrical outlet or within six inches from any edge of an electrical outlet.
- Do not place dispenser in a position where users must reach over an electrical outlet to access the dispenser.
- It is the installers responsibility to ensure installation of unit complies with all applicable codes, standards, and regulatory requirements including building codes and electrical codes.

Disposal

- Damaged or malfunctioning product should be disposed of immediately to avoid potential of injury
- Products should be disposed of in accordance with applicable regulations

Cleaning instructions

- Clean dispenser with mild detergent and soft cloth



essity

Manufactured by Essity Hygiene and Health AB

SE-40503 Göteborg, Sweden

Visiting address: Mölndals Bro 2, Mölndal

www.essity.com, www.torkglobal.com

Made in Poland

Patents/Brevets/Patentes: www.essity.com/patents

Essity UK Limited

Southfields Road, Dunstable,

Bedfordshire, LU6 3EJ, UK