

Montageanleitung / Assembly instructions / Instructions de montage Basiswagen / basic cart / modèle de base

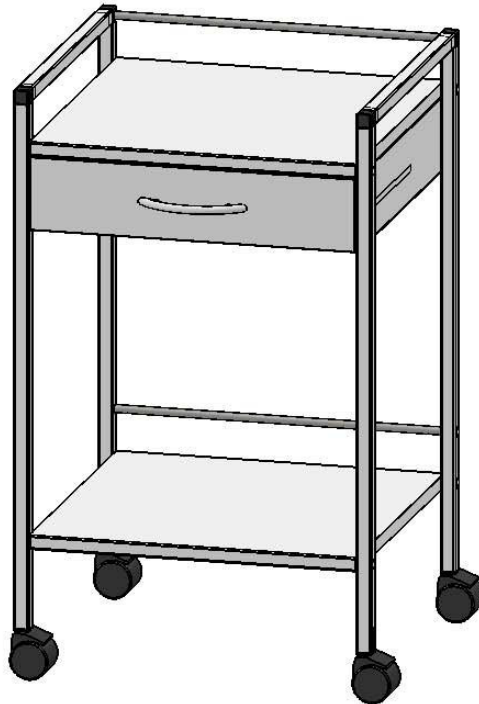

Alle Belastungsangaben sind Maximalwerte unter Berücksichtigung der Kippsicherheit EN 60601/1.

All load figures are maximum values taking into account stability as per EN 60601/1.

Les indications relatives aux charges sont des Valeurs maximales, compte tenu de la stabilité Au renversement, conformément à EN 60601/1.

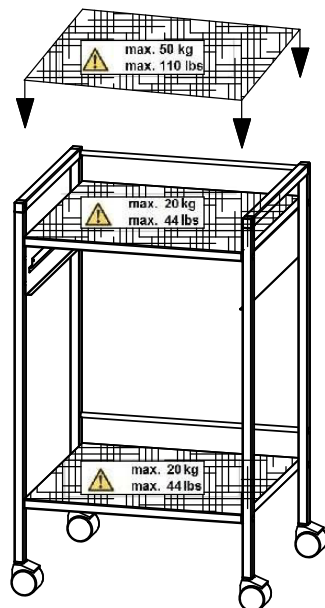
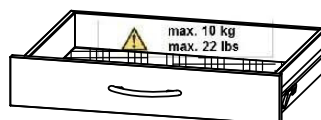

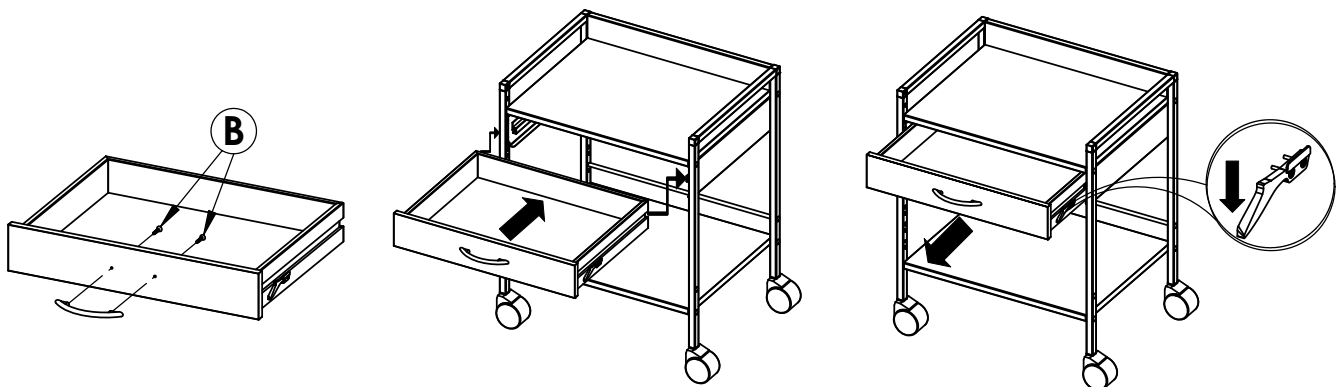
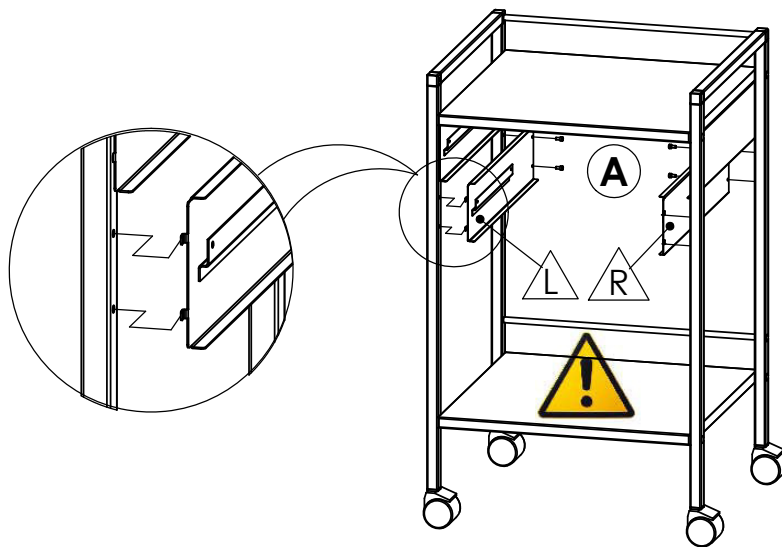
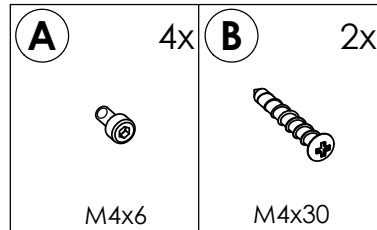

Abschließend alle Schrauben noch mal festziehen.
Finally retighten all screws.
Reserer ensuite toutes les vis.

Montageanleitung / Assembly instructions / Instructions de montage Schublade / drawer / tiroir

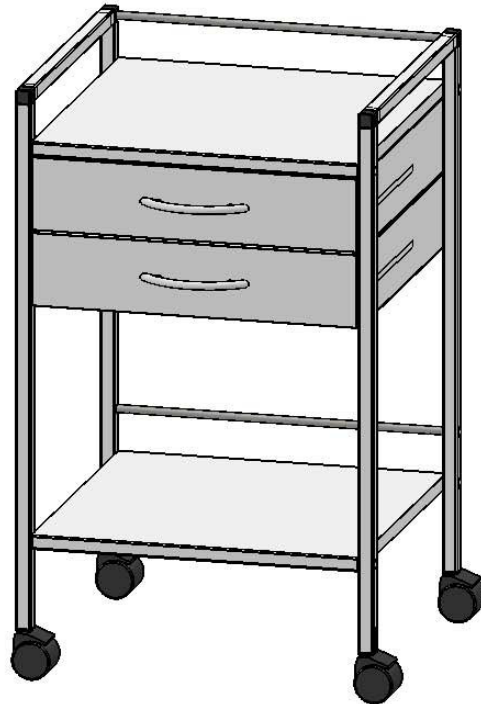

Alle Belastungsangaben sind Maximalwerte unter Berücksichtigung der Kippsicherheit EN 60601/1.

All load figures are maximum values taking into account stability as per EN 60601/1.

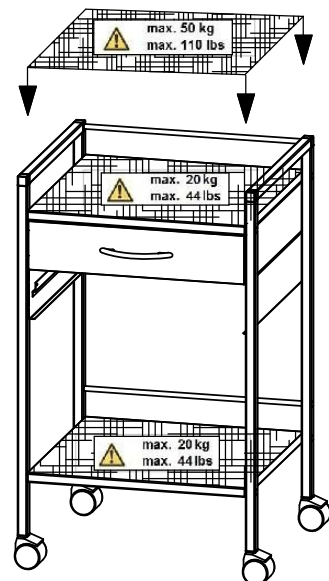
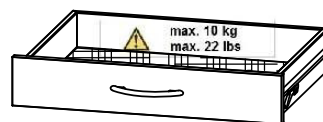

Les indications relatives aux charges sont des Valeurs maximales, compte tenu de la stabilité Au renversement, conformément à EN 60601/1.



Vielzweckwagen 08/16[®]

HAEBERLE

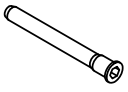
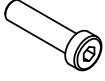
Mobile Arbeitsplätze

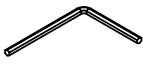
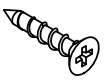
A	4x	B	8x	C	4x	D	10x	E	4x	F	1x	G	2x
													
M4x6		6,3x50 SW4		DIN7984 M6x20		Art.-Nr. 12140				SW4		M4x30	

